



ATS fanSINK™ with maxiGRIP™ Attachment

ATS PART # ATS-61450K-C1-R0

Features & Benefits

- « X-Cut straight fin heat sink fins offer omnidirectional air flow for optimum thermal performance independent of PCB lay-out
- « Stainless steel screw fan attachment ensures dependable long-term fan to heat sink assembly. 4-40 thread screws are supplied in 4 lengths (1/2", 3/4", 7/8", 1"). Contact ATS for custom options available.
- « Product hole pattern is 37 mm C-C (center to center)
- « Component Attachment: ATS maxiGRIP™ is a proven high reliability mechanical attachment system
- « Meets Telecordia GR-63-Core Office Vibration; ETSI 300 019 Transportation Vibration; and MIL-STD-810 Shock Testing and Unpackaged Drop Testing Standards
- « maxiGRIP™ hardware includes a high performance plastic frame clip and 300 Series stainless steel spring clip- avoiding PCB through holes
- « Provided with pre-assembled Thermal Interface Material (TIM) centered on base
- « “Keep-Out” Requirements: An “Un-Populated” boarder zone of 5 mm around the component is necessary to facilitate the installation/ removal of the maxiGRIP™. Please refer to the maxiGRIP™ Keep-Out Guidelines and Installation/Removal Instructions for further details

FAN NOT INCLUDED

Fan type is specific to individual customer requirements and needs to be independently sourced.

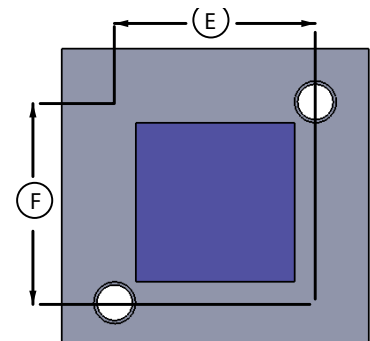
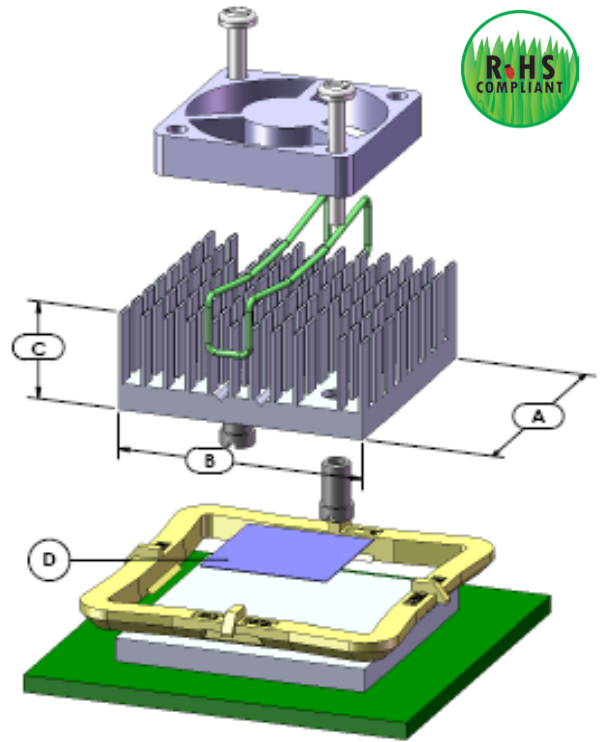

*Images above is for illustration purposes only.

Suggested Fan Details

DIMENSIONS	PART #	DISTRIBUTOR	VOLTAGE	THERMAL RESISTANCE
45 x 45 x 10 mm	KD0545PFS1	DIGI-KEY	5V	0.66 °C/W
45 x 45 x 10 mm	KD1245PFS1	DIGI-KEY	12V	0.66 °C/W

Heat Sink Details

DIM A	DIM B	DIM C	DIM D	DIM E	DIM F	INTERFACE MATERIAL	FINISH	ATTACHMENT	FAN
45 mm	45 mm	14.5 mm	32 x 32 mm	37 mm	37 mm	Chomerics T412	Blk Anodized	maxiGRIP™	Customer Supplied

NOTES:

- 1) Fan not included. Fan type is specific to individual customer requirements and needs to be independently sourced.
- 2) Dimension A and B refers to component size.
- 3) Dimension C refers to the heat sink height from bottom of the base to the top of the fin field.
- 4) Dimension D refers to the size of thermal interface material (TIM) applied to heat sink.
- 5) Dimension E and F refers to hole spacing dimensions.
- 6) Thermal data reference only. Actual performance may vary by application.
- 7) ATS reserves the right to update or change its products without notice.
- 8) Optional maxiGRIP™ Installation/Removal Tool Set P/N: MGT450
- 9) Contact ATS to learn about custom options available.



ATS ADVANCED THERMAL SOLUTIONS, INC.
Innovations in Thermal Management®

For more information, to find a distributor or to place an order, visit www.qats.com or call 781.769.2800