



Raspberry gPlo

Introduction

Relative to its size the Raspberry Pi is a powerhouse of a computer – it can drive HDMI displays, process mouse, keyboard, and camera inputs, connect to the Internet, and run full-featured Linux distributions. But it's more than just a small computer, it's a hardware prototyping tool! The Pi has **bi-directional I/O pins**, which you can use to drive LEDs, spin motors, or read button presses.

This tutorial applies to the Raspberry Pi Model B, the Raspberry Pi Model B+ and the new Raspberry Pi 2 Model B.

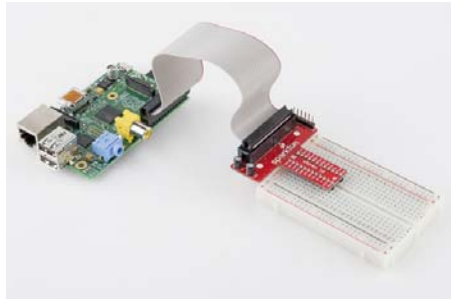

Example Pi Wedge on a model B

Driving the Raspberry Pi's I/O lines requires a bit of programming. Programming in what language? Take your pick! A quick glance at the Raspberry Pi GPIO examples shows that there are dozens of programming-language-choices. We've pared that list down, and ended up with two really solid, easy tools for driving I/O: Python and C (using the WiringPi library).

If you've never driven an LED or read in a button press using the Raspberry Pi, this tutorial should help to get you started. Whether you're a fan of the easily-readable, interpretive scripting language Python or more of a die-hard C programmer, you'll find a programming option that suits our needs.

Covered In This Tutorial

In this tutorial we'll show two different approaches to reading and driving the Raspberry Pi's GPIO pins: **python** and **C**. Here's a quick overview of what's covered:







- GPIO Pinout – An overview of the Pi's GPIO header.
- **Python API and Examples**

- RPi.GPIO API – An overview of the Python functions you can use to drive GPIO.
- RPi.GPIO Example – An example Python script that shows off both input and output functionality.
- **C (and WiringPi) API and Examples**
 - WiringPi Setup and Test – How to install WiringPi and then take it for a test drive on the command line.
 - WiringPi API – An overview of the basic functions provided by the WiringPi library.
 - WiringPi Example – A simple example program that shows off WiringPi's input and output capabilities.
- Using an IDE – How to download and install Geany. Our favorite IDE for programming on the Raspberry Pi.

Each programming language has its share of pros and cons. Python is easy (especially if you're a programming novice) and doesn't require any compilation. C is faster and may be easier for those familiar with the old standby.

What You'll Need

Here's a wishlist-full of everything we used for this tutorial.

Raspberry gPiO SparkFun Wish List	
	<p>Raspberry Pi - Model B DEV-11546 Who wants pi? The Raspberry Pi has made quite a splash since it wa...</p>
	<p>SparkFun Pi Wedge KIT-12652 This is the SparkFun Pi Wedge, a small board that connects to the Ra...</p>
	<p>(2) Breadboard - Self-Adhesive (White) PRT-12002 This is your tried and true white solderless breadboard. It has 2 power...</p>
	<p>Jumper Wires Standard 7" M/M Pack of 30 PRT-11026 If you need to knock up a quick prototype there's nothing like having a...</p>
	<p>Momentary Pushbutton Switch - 12mm Square COM-09190 This is a standard 12mm square momentary button. What we really li...</p>
	<p>Resistor 330 Ohm 1/6 Watt PTH - 20 pack COM-11507 1/6 Watt, +/- 5% tolerance PTH resistors. Commonly used in breadbo...</p>
	<p>LED - Basic Red 5mm COM-09590 LEDs - those blinky things. A must have for power indication, pin stat...</p>

Some further notes on that bill of materials:

- Your Raspberry Pi should have an SD card with **Raspbian installed** on it. Check out our How to Install Raspbian tutorial for help with that.
- We're also assuming you have the necessary **mouse, keyboard and display** hooked up to your Pi.
- Your Pi will need an **Internet connection** to download WiringPi. You can use either Ethernet or WiFi (check out our Raspberry Pi WiFi tutorial for help with that).
- The Pi Wedge isn't quite required, but it does make life a lot easier. If you want to skip the breakout, you can instead use Male-to-Female jumpers to connect from Pi to breadboard.
- Of course, feel free to swap in your preferred button and LEDs.

Suggested Reading

This tutorial will assume you have **Raspbian** installed on your Raspberry Pi. Raspbian is the most popular, well-supported Linux distribution available for the Pi. If you don't have Raspbian set up, check out our [Setting Up Raspbian](#) tutorial before continuing down this rabbit hole.

Other, more general purpose tutorials you might be interested in reading include:

- [Pulse-Width Modulation](#) – You can use PWM to dim LEDs or send signals to servo motors. The RPi has a single PWM-capable pin.
- [Light-Emitting Diodes \(LEDs\)](#) – To test the output capabilities of the Pi, we'll be driving a lot of LEDs.
- [Switch Basics](#) – And to test inputs to the Pi, we'll be using buttons and switches.
- [Pull-Up Resistors](#) – The Pi has internal pull-up (and pull-down) resistors. These are very handy when you're interfacing buttons with the little computer.

Suggested Viewing

Check out our [Raspberry Pi video tutorials](#) if you want a more visual introduction to the Pi!

- [Getting Started With The Raspberry Pi](#)
 - [Part 1](#)
 - [Part 2](#)
 - [Part 3](#)

GPIO Pinout

The Raspberry Pi offers up its GPIO over a standard male header on the board. Over the years the header has expanded from 26 pins to 40 pins while maintaining the original pinout.

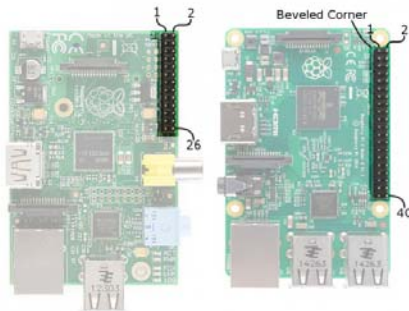

Header configuration for early and late model Pi computers

If you're coming to the Raspberry Pi as an Arduino user, you're probably used to referencing pins with a single, unique number. Programming the Pi's hardware works much the same, each pin has its own number...and then some.

There are (at least) two, different numbering schemes you may encounter when referencing Pi pin numbers: (1) Broadcom chip-specific pin numbers and (2) P1 physical pin numbers. You're usually free to use either number-system, but many programs require that you declare which scheme you're using at the very beginning of your program.

Here's a table showing all 26 pins on the P1 header, including any special function they may have, and their dual numbers:

Raspberry Pi2 GPIO Header					
Pin#	NAME		NAME	Pin#	
01	3.3v DC Power	⚡	DC Power 5v	02	
03	GPIO02 (SDA1, I2C)	⚡	DC Power 5v	04	
05	GPIO03 (SCL1, I2C)	⚡	Ground	06	
07	GPIO04 (GPIO_GCLK)	⚡	(TXD0) GPIO14	08	
09	Ground	⚡	(RXD0) GPIO15	10	
11	GPIO17 (GPIO_GEN0)	⚡	(GPIO_GEN1) GPIO18	12	
13	GPIO27 (GPIO_GEN2)	⚡	Ground	14	
15	GPIO22 (GPIO_GEN3)	⚡	(GPIO_GEN4) GPIO23	16	
17	3.3v DC Power	⚡	(GPIO_GEN5) GPIO24	18	
19	GPIO10 (SPI_MOSI)	⚡	Ground	20	
21	GPIO09 (SPI_MISO)	⚡	(GPIO_GEN6) GPIO25	22	
23	GPIO11 (SPI_CLK)	⚡	(SPI_CE0_N) GPIO08	24	
25	Ground	⚡	(SPI_CE1_N) GPIO07	26	
27	ID_SD (I2C ID EEPROM)	⚡	(PC ID EEPROM) ID_SC	28	
29	GPIO05	⚡	Ground	30	
31	GPIO06	⚡	GPIO12	32	
33	GPIO13	⚡	Ground	34	
35	GPIO19	⚡	GPIO16	36	
37	GPIO26	⚡	GPIO20	38	
39	Ground	⚡	GPIO21	40	

Early Models

Late Models

Rev 1
September 2014

<http://www.element14.com>

Element14 pin description, annotated

Wedge Silk	Python (BCM)	WiringPi GPIO	Name	P1 Pin Number		Name	WiringPi GPIO	Python (BCM)	Wedge Silk
			3.3v DC Power	1	2	5v DC Power			
SDA		8	GPIO02 (SDA1, I2C)	3	4	5v DC Power			
SCL		9	GPIO03 (SCL1, I2C)	5	6	Ground			
G4	4	7	GPIO04 (GPIO_GCLK)	7	8	GPIO14 (TXD0)	15		TXO
			Ground	9	10	GPIO15 (RXD0)	16		RXI
G17	17	0	GPIO17 (GPIO_GEN0)	11	12	GPIO18 (GPIO_GEN1)	1	18	G18
G27	27	2	GPIO27 (GPIO_GEN2)	13	14	Ground			
G22	22	3	GPIO22 (GPIO_GEN3)	15	16	GPIO23 (GPIO_GEN4)	4	23	G23
			3.3v DC Power	17	18	GPIO24 (GPIO_GEN5)	5	24	G24
MOSI		12	GPIO10 (SPI_MOSI)	19	20	Ground			
MISO		13	GPIO09 (SPI_MISO)	21	22	GPIO25 (GPIO_GEN6)	6	25	G25
		(no worky 14)	GPIO11 (SPI_CLK)	23	24	GPIO08 (SPI_CE0_N)	10		CD0
			Ground	25	26	GPIO07 (SPI_CE1_N)	11		CE1
IDSD		30	ID_SD (I2C ID EEPROM)	27	28	ID_SC (I2C ID EEPROM)	31		IDSC
G05	5	21	GPIO05	29	30	Ground			
G6	6	22	GPIO06	31	32	GPIO12	26	12	G12
G13	13	23	GPIO13	33	34	Ground			
G19	19	24	GPIO19	35	36	GPIO16	27	16	G16
G26	26	25	GPIO26	37	38	GPIO20	28	20	G20
			Ground	39	40	GPIO21	29	21	G21

This table shows the Pi pin header numbers, element14 given names, wiringPi numbers, Python numbers, and related silkscreen on the wedge.

Note: The Broadcom pin numbers above relate to Pi Model 2 and later *only*. If you have an older Rev1 Pi, check out this link for your Broadcom pin numbers.

As you can see, the Pi not only gives you access to the **bi-directional I/O pins**, but also Serial (UART), I²C, SPI, and even some PWM (“analog output”).

Hardware Setup

To get a head start you can assemble the circuit now. We'll use this setup for both the C and Python examples. We'll use two LEDs to test the output functionality (digital and PWM), and a button to test the input.

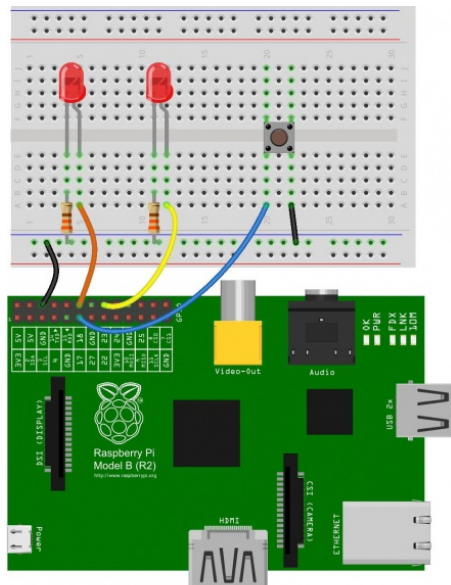

fritzing

connections to original pi

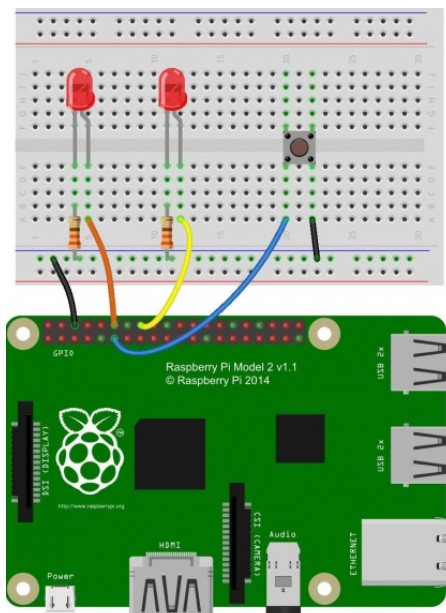

fritzing

connections to the pi B + and pi 2 B

Our **two LEDs** are connected to the **Pi's GPIO 18 and GPIO 23** – those are the Broadcom chip-specific numbers. If you're basing your wiring off the P1 connector pin numbers, that'd be pins 12 and 16.

The **button** is connected to Broadcom **GPIO 17**, aka P1 pin 11.

If you have Pi Wedge, the hookup should be pretty straight-forward. It'll look a little something like this when you're done:

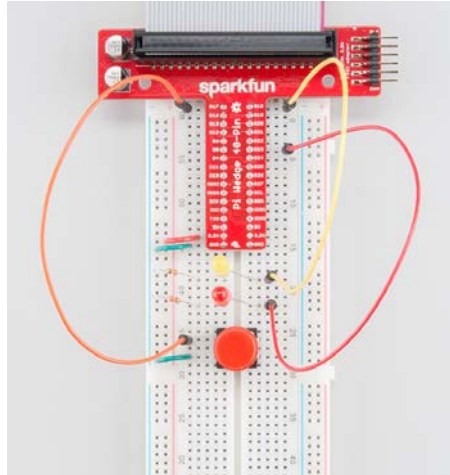

If you don't have a Pi Wedge, male-to-female jumper wires help to make an easy transition from Pi to breadboard.

Python (RPi.GPIO) API

We'll use the RPi.GPIO module as the driving force behind our Python examples. This set of Python files and source is **included with Raspbian**, so assuming you're running that most popular Linux distribution, you don't need to download anything to get started.

On this page we'll provide an overview of the basic function calls you can make using this module.

Setup Stuff

In order to use RPi.GPIO throughout the rest of your Python script, you need to put this statement at the **top of your file**:

```
import RPi.GPIO as GPIO
```

That statement "includes" the RPi.GPIO module, and goes a step further by providing a local name – `GPIO` – which we'll call to reference the module from here on.

Pin Numbering Declaration

After you've included the RPi.GPIO module, the next step is to determine which of the two **pin-numbering schemes** you want to use:

1. `GPIO.BOARD` – Board numbering scheme. The pin numbers follow the pin numbers on header P1.
2. `GPIO.BCM` – Broadcom chip-specific pin numbers. These pin numbers follow the lower-level numbering system defined by the Raspberry Pi's Broadcom-chip brain.

If you're using the Pi Wedge, we recommend using the `GPIO.BCM` definition – those are the numbers silkscreened on the PCB. The `GPIO.BOARD` may be easier if you're wiring directly to the header.

To specify in your code which number-system is being used, use the

`GPIO.setmode()` function. For example...

```
GPIO.setmode(GPIO.BCM)
```

...will activate the Broadcom-chip specific pin numbers.

Both the `import` and `setmode` lines of code are **required**, if you want to use Python.

Setting a Pin Mode

If you've used Arduino, you're probably familiar with the fact that you have to declare a "pin mode" before you can use it as either an input or output. To set a pin mode, use the `setup([pin], [GPIO.IN, GPIO.OUT])` function. So, if you want to set pin 18 as an output, for example, write:

```
GPIO.setup(18, GPIO.OUT)
```

Remember that the pin number will change if you're using the board numbering system (instead of 18, it'd be 12).

Outputs

Digital Output

To write a pin high or low, use the `GPIO.output([pin], [GPIO.LOW, GPIO.HIGH])` function. For example, if you want to set pin 18 high, write:

```
GPIO.output(18, GPIO.HIGH)
```

Writing a pin to `GPIO.HIGH` will drive it to 3.3V, and `GPIO.LOW` will set it to 0V. For the lazy, alternative to `GPIO.HIGH` and `GPIO.LOW`, you can use either `1`, `True`, `0` or `False` to set a pin value.

PWM ("Analog") Output

PWM on the Raspberry Pi is about as limited as can be – one, single pin is capable of it: 18 (i.e. board pin 12).

To initialize PWM, use `GPIO.PWM([pin], [frequency])` function. To make the rest of your script-writing easier you can assign that instance to a variable. Then use `pwm.start([duty cycle])` function to set an initial value. For example...

```
pwm = GPIO.PWM(18, 1000)
pwm.start(50)
```

...will set our PWM pin up with a frequency of 1kHz, and set that output to a 50% duty cycle.

To adjust the value of the PWM output, use the `pwm.ChangeDutyCycle([duty cycle])` function. `[duty cycle]` can be any value between 0 (i.e 0%/LOW) and 100 (i.e 100%/HIGH). So to set a pin to 75% on, for example, you could write:

```
pwm.ChangeDutyCycle(75)
```

To turn PWM on that pin off, use the `pwm.stop()` command.

Simple enough! Just don't forget to set the pin as an output before you use it for PWM.

Inputs

If a pin is configured as an input, you can use the `GPIO.input([pin])` function to read its value. The `input()` function will return either a `True` or `False` indicating whether the pin is HIGH or LOW. You can use an `if` statement to test this, for example...

```
if GPIO.input(17):
    print("Pin 11 is HIGH")
else:
    print("Pin 11 is LOW")
```

...will read pin 17 and print whether it's being read as HIGH or LOW.

Pull-Up/Down Resistors

Remember back to the `GPIO.setup()` function where we declared whether a pin was an input or output? There's an optional third parameter to that function, which you can use to set pull-up or pull-down resistors. To use a pull-up resistor on a pin, add `pull_up_down=GPIO.PUD_UP` as a third parameter in `GPIO.setup`. Or, if you need a pull-down resistor, instead use `pull_up_down=GPIO.PUD_DOWN`.

For example, to use a pull-up resistor on GPIO 17, write this into your setup:

```
GPIO.setup(17, GPIO.IN, pull_up_down=GPIO.PUD_UP)
```

If nothing is declared in that third value, both pull-resistors will be disabled.

Etc.

Delays

If you need to slow your Python script down, you can add delays. To incorporate delays into your script, you'll need to include another module: `time`. This line, at the top of your script, will do it for you:

```
include time
```

Then, throughout the rest of your script, you can use `time.sleep([seconds])` to give your script a rest. You can use decimals to precisely set your delay. For example, to delay 250 milliseconds, write:

```
time.sleep(0.25)
```

The `time` module includes all sorts of useful functions, on top of `sleep`. Check out the reference [here](#).

Garbage Collecting

Once your script has run its course, be kind to the next process that might use your GPIOs by cleaning up after yourself. Use the `GPIO.cleanup()` command at the end of your script to release any resources your script may be using.

Your Pi will survive if you forget to add this command, but it is good practice to include wherever you can.

Now then. Lets incorporate everything we learned here into an example script to try everything out.

Python (RPI.GPIO) Example

Follow along as we use the basic RPI.GPIO functions from the last page to create a simple example GPIO script.

1. Create a File

To begin, we need to create a Python file. You can do this through the GUI-based file explorer. Or, if you want a terminal-based solution, open up **LXTerminal**, and navigate to a folder you'd like the file to live (or create one). And create a new folder with these commands:

```
pi@raspberrypi ~/code $ mkdir python
pi@raspberrypi ~/code $ cd python
```

Create a file – we'll call ours "blinker" – and terminate it with a **.py** extension. Then open it up in your favorite text editor. Nano works, as does Pi's default GUI text editor, Leafpad.

```
pi@raspberrypi ~/code/python $ touch blinker.py
pi@raspberrypi ~/code/python $ leafpad blinker.py &
```

That'll open up a blank text file (the "&" will open it in the background, leaving the terminal in place for future use). Time for some code!

2. Codify

Here's an example sketch that incorporates everything we learned on the last page. It does a little input and output, and even handles some PWM. This assumes you've set up the circuit as arranged on the Hardware Setup page.

```

# External module imports
import RPi.GPIO as GPIO
import time

# Pin Definitons:
pwmPin = 18 # Broadcom pin 18 (P1 pin 12)
ledPin = 23 # Broadcom pin 23 (P1 pin 16)
butPin = 17 # Broadcom pin 17 (P1 pin 11)

dc = 95 # duty cycle (0-100) for PWM pin

# Pin Setup:
GPIO.setmode(GPIO.BCM) # Broadcom pin-numbering scheme
GPIO.setup(ledPin, GPIO.OUT) # LED pin set as output
GPIO.setup(pwmPin, GPIO.OUT) # PWM pin set as output
pwm = GPIO.PWM(pwmPin, 50) # Initialize PWM on pwmPin 100Hz frequency
GPIO.setup(butPin, GPIO.IN, pull_up_down=GPIO.PUD_UP) # Button pin set as input w/ pull-up

# Initial state for LEDs:
GPIO.output(ledPin, GPIO.LOW)
pwm.start(dc)

print("Here we go! Press CTRL+C to exit")
try:
    while 1:
        if GPIO.input(butPin): # button is released
            pwm.ChangeDutyCycle(dc)
            GPIO.output(ledPin, GPIO.LOW)
        else: # button is pressed:
            pwm.ChangeDutyCycle(100-dc)
            GPIO.output(ledPin, GPIO.HIGH)
            time.sleep(0.075)
            GPIO.output(ledPin, GPIO.LOW)
            time.sleep(0.075)
except KeyboardInterrupt: # If CTRL+C is pressed, exit cleanly:
    pwm.stop() # stop PWM
    GPIO.cleanup() # cleanup all GPIO

```

After you've typed all of that in (don't forget your whitespace!) **save**.

Running the Script

The RPi.GPIO module requires administrator privileges, so you'll need to tag a `sudo` on to the front of your Python script call. To run your "blinker.py" script, type:

```
pi@raspberrypi ~/code/python $ sudo python blinker.py
```

With the code running, press the button to turn on the digital LED. The PWM-ing LED will invert its brightness when you press the button as well.

```

pi@raspberrypi: ~/python
File Edit Tabs Help
pi@raspberrypi ~$ sudo python
pi@raspberrypi ~$ cd python
pi@raspberrypi ~$ python $ touch blinker.py
pi@raspberrypi ~$ python $ leafpad blinker.py &
[1] 3004
pi@raspberrypi ~$ python $ sudo python blinker.py
Here we go! Press CTRL+C to exit
pi@raspberrypi ~$

```

Press CTRL+C to cleanly exit the script.

C (WiringPi) Setup

Python is a great GPIO-driving option, especially if you're used to it. But if you're a rickety old programmer, unfamiliar with the whitespace-driven scripting language, and would rather live within the happy confines of C, then let me introduce the WiringPi library.

1) Install Wiring Pi

WiringPi is not included with Raspbian, so, to begin, you'll need to download and install it. That means your Pi will need a connection to the Internet – either via Ethernet or WiFi.

Once your Pi is Internet-enabled, visit the WiringPi homepage for instructions on downloading and installing the library.

We highly recommend using Git to download the latest version. As long as you have Git installed, these commands should be all you need to download and install WiringPi:

```
pi@raspberrypi ~/code $ git clone
git://git.drogon.net/wiringPi
pi@raspberrypi ~/code $ cd wiringPi
pi@raspberrypi ~/code/wiringPi $ git pull origin
pi@raspberrypi ~/code/wiringPi $ cd wiringPi
pi@raspberrypi ~/code/wiringPi/wiringPi $ ./build
```

2) Test Wiring Pi

WiringPi is awesome because it's actually more than just a C library, it includes a **command-line utility** as well! You can test your installation of WiringPi with the `gpio` utility.

Open up a terminal, and try some of these system calls:

```
pi@raspberrypi ~/code $ gpio -g mode 18 output
pi@raspberrypi ~/code $ gpio -g write 18 1
pi@raspberrypi ~/code $ gpio -g write 18 0
```

As long as your LED is still connected to pin 18 it should blink on and off following the last two commands.

Or, to test the button, type:

```
pi@raspberrypi ~/code $ gpio -g mode 17 up
pi@raspberrypi ~/code $ gpio -g read 17
```

Either 0 or 1 will be returned, depending on whether the button is pressed or not. Try typing that last line again while pressing the button.

The `gpio` utility, as stated in the manual, is a "swiss army knife" command-line tool. We highly recommend checking out the man page (type `man gpio`) to discover everything it can do.

If you're ready to get on with some C-style programming, head over to the next page. We'll overview some of the most useful functions provided by the WiringPi library.

C (WiringPi) API

On this page we'll discuss some of the most useful functions provided by the WiringPi library. It's tailored to look a lot like Arduino, so if you've done any Arduino programming some of this may look familiar.

Setup Stuff

To begin, you'll need to include the library. At the beginning of your program, type:

```
#include <wiringPi.h>
```

After you've included the library, your first steps should be to initialize it. This step also determines which **pin numbering scheme** you'll be using throughout the rest of your program. Pick **one of these** function calls to initialize the library:

```
wiringPiSetup(); // Initializes wiringPi using wiringPi's simplified number system.
wiringPiSetupGpio(); // Initializes wiringPi using the Broadcom GPIO pin numbers
```

WiringPi's simplified number system introduces a third pin-numbering scheme. We didn't show it in the table earlier, if you want to use this scheme, check out their pins page for an overview.

Pin Mode Declaration

To set a pin as either an input or output, use the `pinMode([pin], [mode])` function. Mode can be either `INPUT`, `OUTPUT`, or `PWM_OUTPUT`.

For example, to set pin 22 as an input, 23 as an output, and 18 as a PWM, write:

```
wiringPiSetupGpio()
pinMode(17, INPUT);
pinMode(23, OUTPUT);
pinMode(18, PWM_OUTPUT);
```

Keep in mind that the above example uses the Broadcom GPIO pin-numbering scheme.

Digital Output

The `digitalWrite([pin], [HIGH/LOW])` function can be used to set an output pin either HIGH or LOW. Easy enough, if you're an Arduino user.

To set pin 23 as HIGH, for example, simply call:

```
digitalWrite(23, HIGH);
```

PWM ("Analog") Output

For the lone PWM pin, you can use `pwmWrite([pin], [0-1023])` to set it to a value between 0 and 1024. As an example...

```
pwmWrite(18, 723);
```

...will set pin 18 to a duty cycle around 70%.

Digital Input

If you're an Arduino veteran, you probably know what comes next. To read the digital state of a pin, `digitalRead([pin])` is your function. For example...

```
if (digitalRead(17))
    printf("Pin 17 is HIGH\n");
else
    printf("Pin 17 is LOW\n");
```

...will print the status of pin 22. The `digitalRead()` function returns 1 if the pin is HIGH and 0 if it's LOW.

Pull-Up/Down Resistors

Need some pull-up or pull-down resistors on your digital input? Use the `pullUpDnControl([pin], [PUD_OFF, PUD_DOWN, PUD_UP])` function to pull your pin.

For example, if you have a button on pin 22 and need some help pulling it up, write:

```
pullUpDnControl(17, PUD_UP);
```

That comes in handy if your button pulls low when it's pressed.

Delays

Slowing down those blinking LEDs is always useful – assuming you actually want to differentiate between on and off. WiringPi includes two delay functions to choose from: `delay([milliseconds])` and `delayMicroseconds([microseconds])`. The standard delay will halt the program flow for a specified number of milliseconds. If you want to delay for 2 seconds, for example, write:

```
delay(2000);
```

Or you can use `delayMicroseconds()` to get a more precise, microsecond-level delay.

Now that you know the basics, let's apply them to an example piece of code.

C (WiringPi) Example

The intention of WiringPi is to make your I/O code look as Arduino-ified as possible. However keep in mind that we're no longer existing in the comfy confines of Arduino – there's no `loop()` or `setup()`, just `int main(void)`.

Follow along here as we create an example C file, incorporate the WiringPi library, and compile and run that program.

Create `blinker.c`

Using the terminal, navigate to a folder of your choice and create a new file – “`blinker.c`”. Then open that file in a text editor (Nano or Leafpad are included with Raspbian).

```
pi@raspberrypi ~/code $ mkdir c_example
pi@raspberrypi ~/code $ cd c_example
pi@raspberrypi ~/code/c_example $ touch blinker.c
pi@raspberrypi ~/code/c_example $ leafpad blinker.c &
```

The commands above will open your “`blinker.c`” file in Leafpad, while leaving your terminal functioning – in-directory – in the background.

Program!

Here's an example program that includes a little bit of everything we talked about on the last page. Copy and paste, or write it yourself to get some extra reinforcement.

```

#include <stdio.h> // Used for printf() statements
#include <wiringPi.h> // Include WiringPi library!

// Pin number declarations. We're using the Broadcom chip pin
numbers.
const int pwmPin = 18; // PWM LED - Broadcom pin 18, P1 pin 12
const int ledPin = 23; // Regular LED - Broadcom pin 23, P1 pin
16
const int butPin = 17; // Active-low button - Broadcom pin 1
7, P1 pin 11

const int pwmValue = 75; // Use this to set an LED brightness

int main(void)
{
    // Setup stuff:
    wiringPiSetupGpio(); // Initialize wiringPi -- using Broad
com pin numbers

    pinMode(pwmPin, PWM_OUTPUT); // Set PWM LED as PWM output
    pinMode(ledPin, OUTPUT); // Set regular LED as output
    pinMode(butPin, INPUT); // Set button as INPUT
    pullUpDnControl(butPin, PUD_UP); // Enable pull-up resisto
r on button

    printf("Blinker is running! Press CTRL+C to quit.\n");

    // Loop (while(1)):
    while(1)
    {
        if (digitalRead(butPin)) // Button is released if thi
s returns 1
        {
            pwmWrite(pwmPin, pwmValue); // PWM LED at bright s
etting
            digitalWrite(ledPin, LOW); // Regular LED off
        }
        else // If digitalRead returns 0, button is pressed
        {
            pwmWrite(pwmPin, 1024 - pwmValue); // PWM LED at d
im setting
            // Do some blinking on the ledPin:
            digitalWrite(ledPin, HIGH); // Turn LED ON
            delay(75); // Wait 75ms
            digitalWrite(ledPin, LOW); // Turn LED OFF
            delay(75); // Wait 75ms again
        }
    }

    return 0;
}

```

Once you've finished, **Save** and return to your terminal.

Compile and Execute!

Unlike Python, which is an interpreted language, before we can run our C program, we need to build it.

To **compile our program**, we'll invoke `gcc`. Enter this into your terminal, and wait a second for it to finish compiling:

```

pi@raspberrypi ~/code/c_example $ gcc -o blinker
blinker.c -l wiringPi

```

That command will create an executable file – “blinker”. The “-I wiringPi” part is important, it loads the wiringPi library. A successful compilation won’t produce any messages; if you got any errors, try to use the messages to track them down.

Type this to **execute your program**:

```
pi@raspberrypi ~/code/c_example $ sudo ./blinker
```

The blinker program should begin doing it’s thing. Make sure you’ve set up the circuit just as modeled on the hardware setup page. Press the button to blink the LED, release to have it turn off. The PWM-ing LED will be brightest when the button is released, and dim when the button is pressed.

If typing all of that code in a bland, black-and-white, non-highlighting editor hurt your brain, check out the next page where we introduce a simple IDE that makes your programming more efficient.

Using an IDE!

Thus far we’ve been using simple text-editors – Leafpad or Nano – to write our Python and C programs. So seasoned programmers are probably missing a whole lot of features assumed of even the most basic editors: auto-tabbing, context-highlighting, even automated building. If you want to incorporate any of those features, we recommend using an IDE (integrated development environment). One of our favorite Pi IDE’s is Geany, here’s how to get it up and running.

Download and Install Geany

Geany isn’t included with Raspbian, so you’ll need an Internet connection to download it. You can use the magical `apt-get` utility to install it with this command:

```
pi@raspberrypi ~/code $ sudo apt-get update
pi@raspberrypi ~/code $ sudo apt-get install geany
```

Once installed, you can run Geany by going to the “Start” menu, and looking under the “Programming” tab.

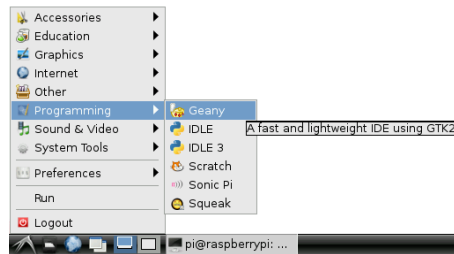

Or, from the terminal, you can type `sudo geany`. You can even open a file in Geany, directly from the command line. To open our previous C file, for example, type `sudo geany blinker.c`.

Using Geany...

Once Geany is running, you can create a new file by going to File > New. Saving the file as either “.c” or “.py” (or any other common language file extension) will immediately inform Geany what kind of language you’re working with, so it can start highlighting your text.

Geany can be used with most languages, including the Python and C examples we’ve just examined. Some tweaks to the default IDE options are necessary, though. Here’s an overview of using Geany with each language.

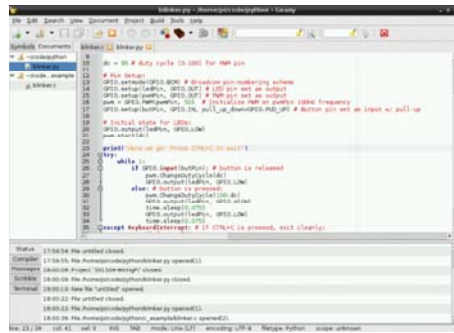

No building required with Python! Once your script is written, simply click the “Execute” gear up top. Again, running will produce a separate terminal to pop up. To exit, simply press CTRL+C.

Geany has tons of features beyond what we’ve covered here. Check out the tabs at the bottom. Check out the menus up top. Experiment and see how the IDE can make your programming life easier!

Resources & Going Further

Now that you know how to blink your Pi’s LEDs, check out some of these resources for going further:

- RPi Low-level peripherals – A Wiki with tons of details on using the Raspberry Pi’s GPIO peripherals.
- WiringPi Homepage – The home of WiringPi and a variety of other Raspberry-Pi-related tools. Check it out!
- RPi.GPIO Homepage – Home of the Raspberry Pi GPIO python module. Great source for API and documentation.

If you’re looking for some project inspiration, here are some more SparkFun tutorials where you’ll be able to leverage your newfound Pi programming skills:

- Raspberry Pi Twitter Monitor – How to use a Raspberry Pi to monitor Twitter for hashtags and blink an LED.
- Getting Started with the BrickPi – How to connect your Raspberry Pi to Lego Mindstorms, using the BrickPi.
- pcDuino 2 Hookup Guide – An introduction to the pcDuino – an equally (if not more) powerful single board computer.